

REVISIONS			
REV.	DESCRIPTION	DATE	ECN
A	INITIAL RELEASE	4/29/09	1174

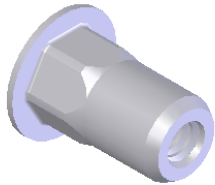
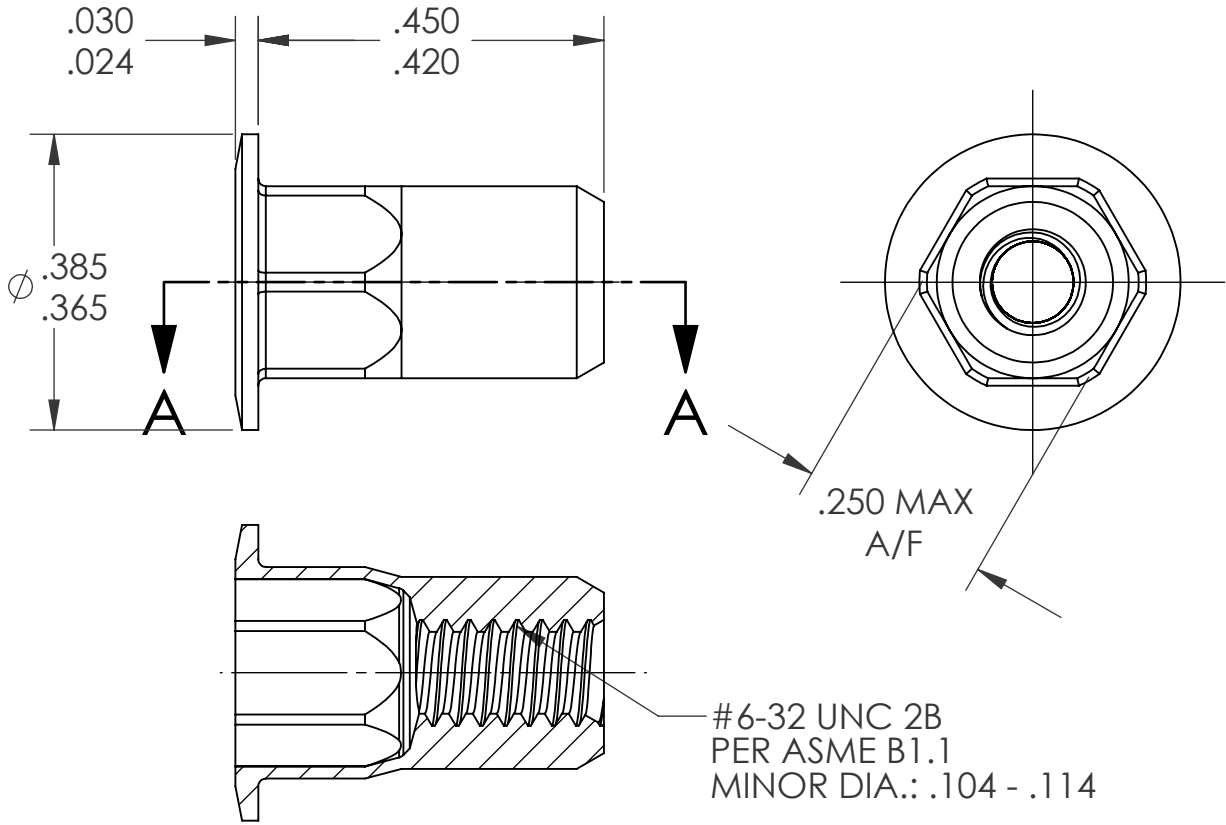

SECTION A-A

NOTE:

1. GRIP RANGE: .080 - .130
2. HOLE SIZE: .250 +.004/-.000 A/F AFTER ALL APPLIED FINISHES.
3. INSTALLED LENGTH: .295 MAX.
4. LUBRICATION: WAX
5. INSTALLATION TOOL: SSG 801 SPIN SPIN

PROPRIETARY AND CONFIDENTIAL
 THIS DRAWING, AND THE INFORMATION CONTAINED HEREIN, ARE THE PROPERTY OF SHEREX AND ARE NOT TO BE USED IN ANY MANNER DETRIMENTAL TO THE INTEREST OF THE COMPANY.
 SHEREX SOLUTIONS RESERVES THE RIGHT TO REVISE PART/DRAWING WITHOUT NOTICE.

		UNLESS OTHERWISE SPECIFIED:		NAME	DATE		
		DIMENSIONS ARE IN INCHES TOLERANCES: ANGULAR: MACH ±1 BEND ±1 TWO PLACE DECIMAL ±.01 THREE PLACE DECIMAL ±.002		DRAWN	TWR		4/29/09
		INTERPRET GEOMETRIC TOLERANCING PER: ASME Y14.5M-1994		CHECKED			
		MATERIAL		ENG APPR.	JVK		4/29/09
		5056 ALUMINUM		MFG APPR.			
		FINISH		Q.A.	JVK	4/29/09	
		NONE		COMMENTS:		TITLE: LARGE FLANGE SEMI HEX	
NEXT ASSY	USED ON			E-mail: info@sherex.com www.sherex.com Phone: 866-474-3739 Fax: 716-875-0358			
APPLICATION		DO NOT SCALE DRAWING		SIZE DWG. NO. A CAH3-0632-130		REV A	
				SCALE: 2:1 WEIGHT: kg		SHEET 1 OF 1	