

REVISIONS			
REV.	DESCRIPTION	DATE	ECN
A	INITIAL RELEASE	4/30/09	1174

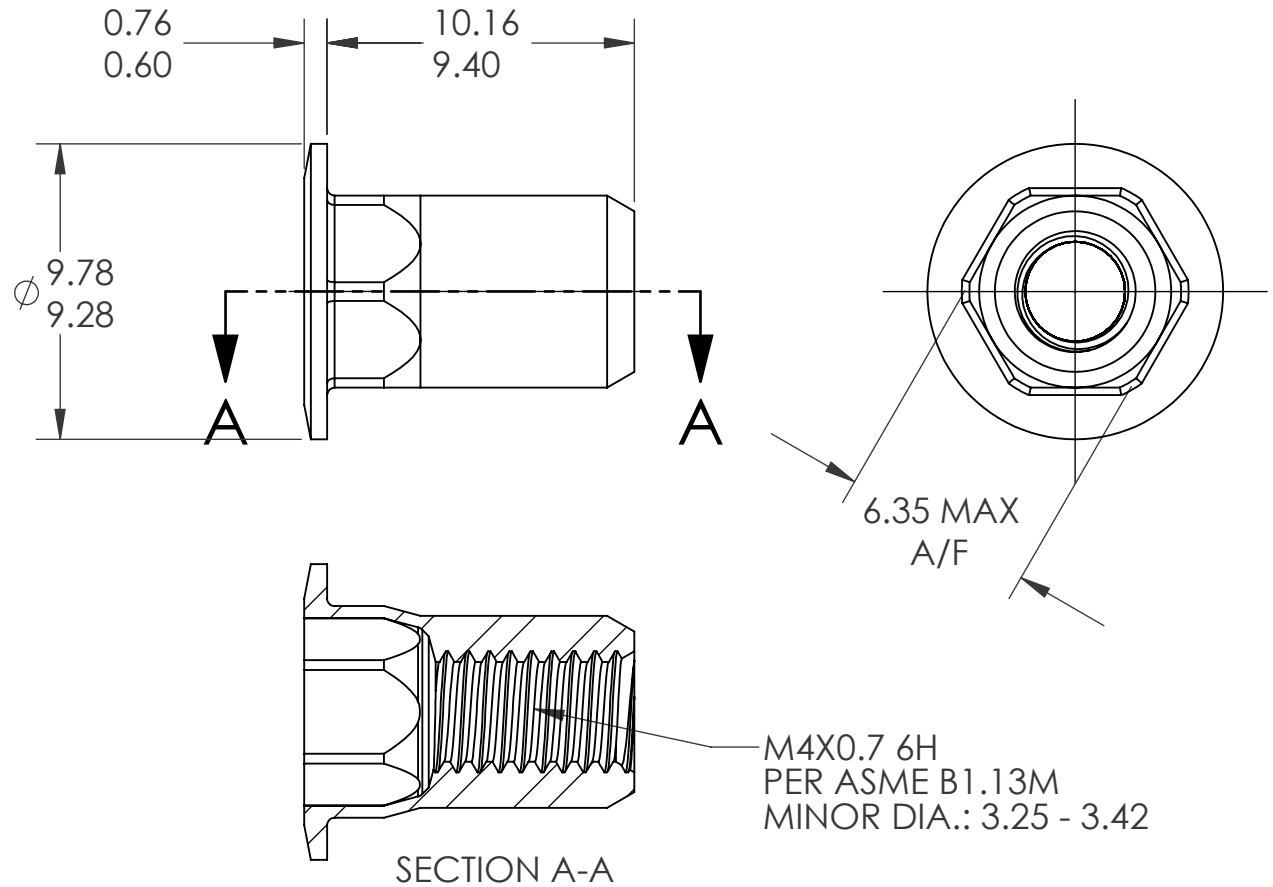

NOTE:

1. GRIP RANGE: 0.5 - 2.0
2. HOLE SIZE: 6.35 +0.1/-0.0 A/F AFTER ALL APPLIED FINISHES.
3. INSTALLED LENGTH: 7.49 MAX.
4. LUBRICATION: WAX
5. INSTALLATION TOOL: SSG 801 SPIN SPIN

PROPRIETARY AND CONFIDENTIAL

THIS DRAWING, AND THE INFORMATION CONTAINED HEREIN, ARE THE PROPERTY OF SHEREX AND ARE NOT TO BE USED IN ANY MANNER DETRIMENTAL TO THE INTEREST OF THE COMPANY.
SHEREX SOLUTIONS RESERVES THE RIGHT TO REVISE PART/DRAWING WITHOUT NOTICE.

		UNLESS OTHERWISE SPECIFIED:		NAME	DATE
		DIMENSIONS ARE IN MILLIMETERS TOLERANCES: ANGULAR: MACH ± 1 BEND ± 1 ONE PLACE DECIMAL ± 0.10 TWO PLACE DECIMAL ± 0.05	DRAWN	TWR	4/30/09
		INTERPRET GEOMETRIC TOLERANCING PER: ASME Y14.5M-1994	CHECKED		
		MATERIAL	ENG APPR.	JVK	4/30/09
		5056 ALUMINUM	MFG APPR.		
		FINISH	Q.A.	JVK	4/30/09
		NONE	COMMENTS:		
			E-mail: info@sherex.com		
			www.sherex.com		
			Phone: 866-474-3739		
			Fax: 716-875-0358		
NEXT ASSY	USED ON				
APPLICATION		DO NOT SCALE DRAWING			

		
TITLE:		
LARGE FLANGE SEMI HEX		
SIZE DWG. NO.		REV
A	CAH3-470-2.0	A
SCALE: 2:1	WEIGHT: kg	SHEET 1 OF 1