



Quick Start Manual



FLEX-5S

Threaded Insert Power Tool Pull to Stroke Set Up

Part of the FLEX family of modular-based tooling. FLEX tooling has the capability to be upgraded from the original base tool. Upgrades include process-monitoring, conversion to an in-line tool, conversion to a split tool with a remote booster, and conversion to a pull to pressure tool.

SAFETY.....	2
TOOL OVERVIEW.....	3
TOOL SIZE CAPABILITIES.....	4
TOOL SPECIFICATIONS.....	5
AIR SERVICE.....	6
HEAD SET ASSEMBLY.....	6
HEAD SET COMPONENTS.....	7-8
STROKE ADJUSTMENT PROCEDURE.....	9
OPERATION.....	9
MAINTENANCE.....	10
TROUBLESHOOTING.....	11
PROCESS MONITORING.....	12
SHEREX TOOL SHOWCASE.....	13
SHEREX PRODUCT LINE SHOWCASE.....	14

Sherex Warranty

Sherex Fastening Solutions FLEX-5S carries a 6 month warranty against defects that are caused by faulty materials or workmanship. Sherex warranty period commences from the date of delivery which is confirmed either by the invoice or delivery note. The warranty becomes invalidated if the installation tool is misused or not serviced, maintained, and operated according to the instructions in the Quick Start and Repair Manuals.

S SAFETY

- ⓘ **DO NOT USE THIS TOOL FOR ANY PURPOSE OTHER THAN THOSE SPECIFIED.**
- ⓘ **DO NOT USE ANY EQUIPMENT ALONG WITH THE TOOL THAT HAS NOT BEEN RECOMMENDED OR PROVIDED BY SHEREX FASTENING SOLUTIONS.**
 - Failure to do so could result in voided warranty and/or personal injury
- ⓘ **THIS TOOL MUST BE KEPT IN EXCELLENT CONDITION AND SHOULD BE CHECKED BY SPECIALIZED PERSONNEL ON A REGULAR BASIS TO DETECT DAMAGES AND EVALUATE ITS OPERATING CONDITION.**
- ⓘ **ALWAYS DISCONNECT THE AIR SUPPLY BEFORE SET UP, ADJUSTMENT, OR REMOVAL OF THE HEAD SET.**
- ⓘ **AIR INLET SHALL NOT EXCEED 7 BAR (102 PSI).**
- ⓘ **DO NOT USE THE TOOL WITHOUT OIL PLUG IN PLACE.**







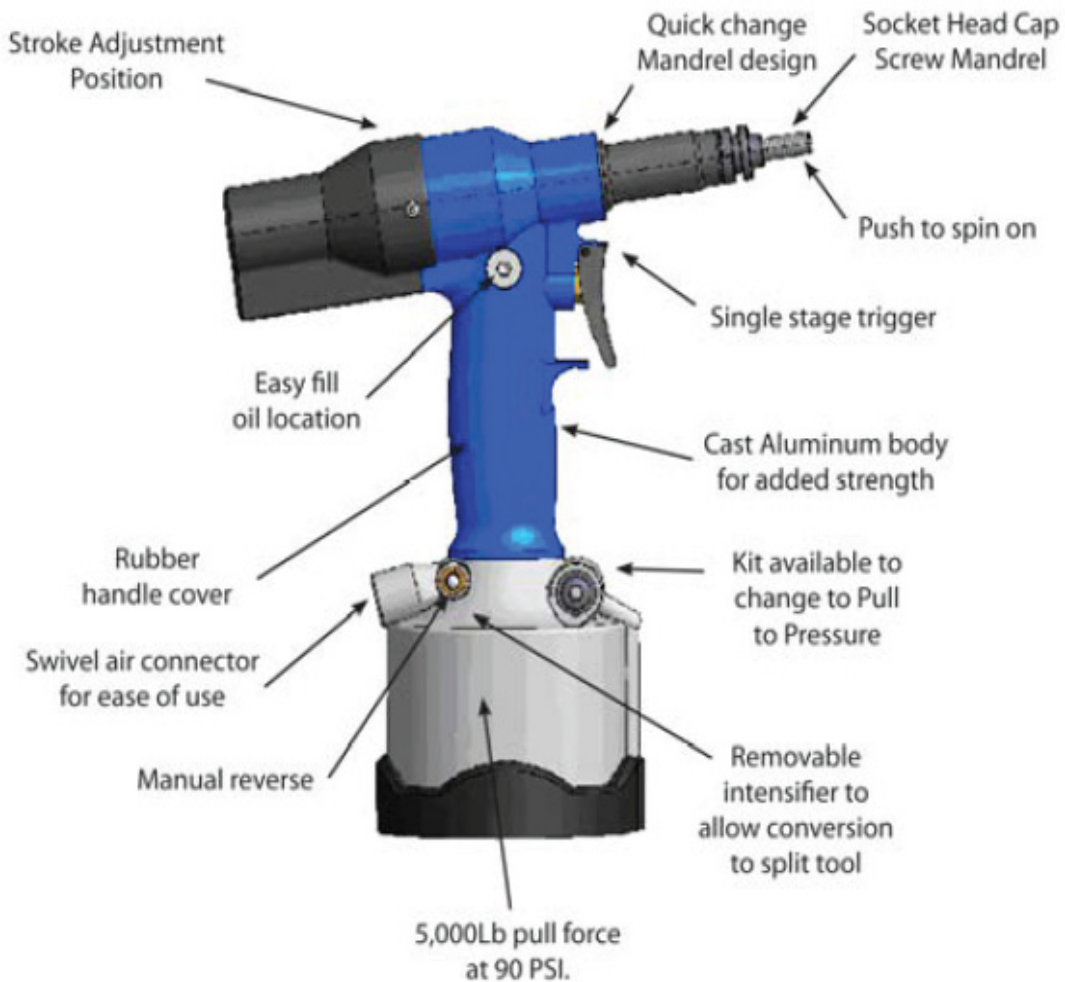



























































TOOL OVERVIEW

The FLEX-5S tool is designed for installing Sherex threaded insert/rievet nuts. The tool utilizes a pull to stroke installation method. The advantage with this method is that the pulling distance of the tool can be set to a specified distance ensuring the rivet nut insert is pulled to the same position (distance) with each actuation of the tool. Contact Sherex for the conversion instructions for changing this tool to a pull to pressure (FLEX-5P) installation method.

The tool is designed to install rivet nuts from M3 to M10 & #4-40 to 3/8-24. The recommended operating air pressure is between 5 - 7 bar (72.5 - 101.5 PSI).



SHEREX PART NUMBER	FLEX TOOL DESCRIPTION
FLEX-5P	Pull to Pressure Tool
FLEX-5S	Pull to Stroke Tool
FL5-KIT-P2S	Pressure to Stroke Conversion Kit
FL5-KIT-S2P	Stroke to Pressure Conversion Kit

		SHEREX® Rivet Nut Series					
Thread Sizes & Materials	CAL	CPB CPN	CA	CFT CFW	TU	CLM CKM	
	CAK CAH CAO		CFH				
#6 & M3							
Aluminum	<i>Flex 5S ONLY</i>	X	<i>Flex 5S ONLY</i>	<i>Flex 5S ONLY</i>	<i>Flex 5S ONLY</i>	<i>Flex 5S ONLY</i>	
Steel		X					
Stainless Steel		X					
#8 & M4							
Aluminum	<i>Flex 5S ONLY</i>	X	<i>Flex 5S ONLY</i>	<i>Flex 5S ONLY</i>	<i>Flex 5S ONLY</i>	<i>Flex 5S ONLY</i>	
Steel		X					
Stainless Steel		X					
#10 & M5							
Aluminum		X					
Steel		X					
Stainless Steel		X					
1/4 & M6							
Aluminum		X					
Steel		X					
Stainless Steel		X					
5/16 & M8							
Aluminum		X		X			
Steel		X		X			
Stainless Steel	<i>Consult Sherex</i>	X	X	X		<i>Consult Sherex</i>	
3/8 & M10							
Aluminum		X	X	X			
Steel		X	X	X			
Stainless Steel	<i>Consult Sherex</i>	X	X	X		<i>Consult Sherex</i>	

	FLEX-5 Tool Recommended
X	FLEX-5 Tool Not Recommended

The FLEX-5P & FLEX-5S can install all RIV-FLOAT® & RIV-FLOAT®-SHORT Rivet Nuts up to 5/16-24 (M8)

Reference Page 8 for RIV-FLOAT® & RIV-FLOAT®-SHORT Head Set Part Numbers

SPECIFICATIONS

FLEX-5S	Tool Specifications		
AIR PRESSURE	Minimum - Maximum	5 – 7 bar	72-101 psi
STROKE	Maximum	7 mm	.280 in
MOTOR SPEED	SPIN ON	1500 rpm	
	SPIN OFF	2000 rpm	
PULL FORCE	@ 6.2 bar	22.25 kN	5,000 lbf
CYCLE TIME	Approximately	2.5 sec	
NOISE LEVEL	Less than	70 dB(A)	
WEIGHT	Without kit	1.9 kg	4.2 lbs
VIBRATION	Less than	2.5 m/s²	
PLACING FEATURES	Inserts	M3 – M10 #4-40 – 3/8-24	
<small>Contact Sherex should you require a pull to stroke setup for this tool (FLEX 5P)</small>			

FLEX-5S TOOL DIMENSIONS

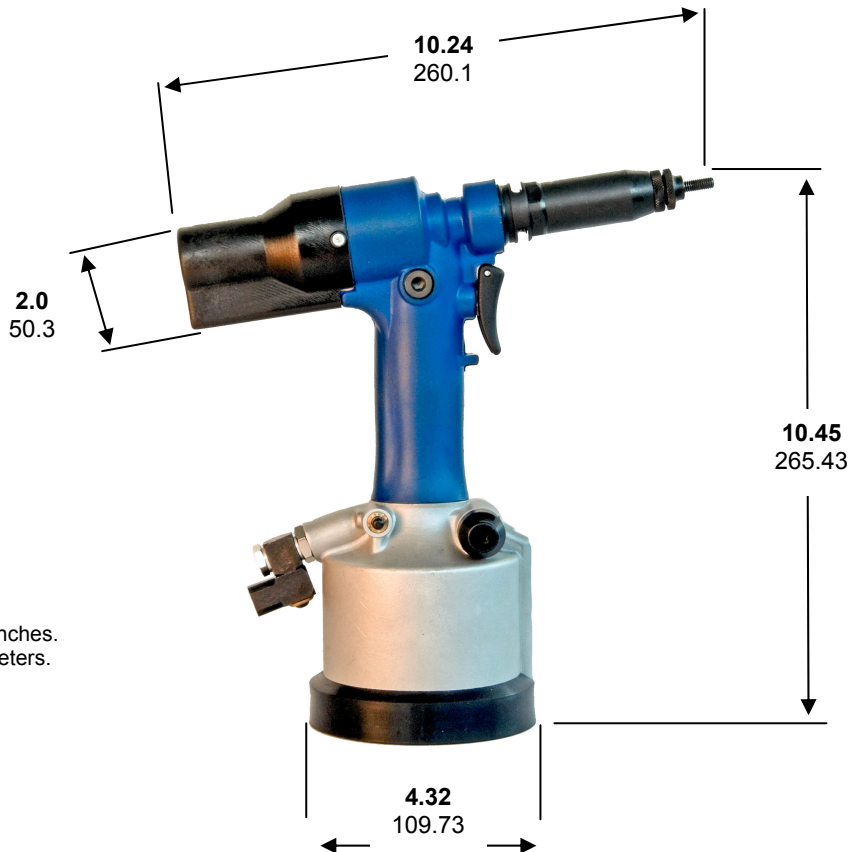

AIR SUPPLY

We suggest you use a pressure regulator and automatic oiling / filtering system on the main air supply, to ensure its maximum life cycle with reliable trouble free use.

HEAD SET ASSEMBLY

ASSEMBLY INSTRUCTIONS

IMPORTANT
DISCONNECT THE AIR SUPPLY WHEN SETTING UP OR REMOVING A HEAD SET.

- Choose the proper head set.
- Remove the nose case, if still mounted.
- Unscrew the adaptor nut while moving away the stop pins.
- Insert hex driver **4** into hex hole on spindle, place socket head cap screw (mandrel) **3** on to hex driver **4** and reducing sleeve **5** on mandrel **3**.
- Hold the adaptor nut, ensure the stop pins are seated in the last possible notch on the adaptor nut (may require you to turn forward 1 notch).
- Screw on the nose case into the handle casting.
- Screw on the anvil **1/2** onto the nose case.
- To remove the equipment, do the reverse operation.

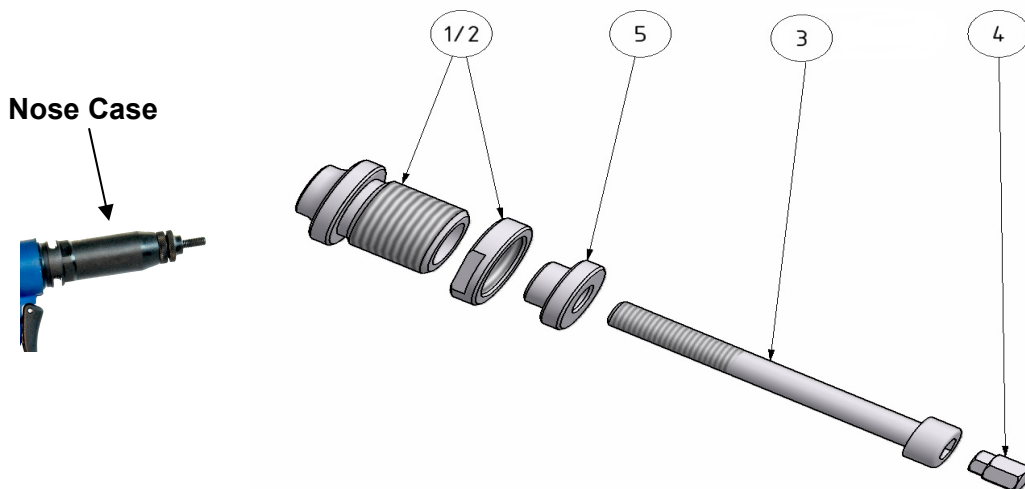

PLACING RIVET NUT ONTO MANDREL- LENGTH CHECK

- Keeping the tool disconnected from air supply, place an insert on mandrel **3** and adjust anvil **1** and lock nut **2** in order to match the insert and mandrel end. It is ideal to have 1-2 threads of the mandrel protruding from the back of the rivet nut; this will ensure full thread engagement during the installation process. Lock position by tightening lock nut **2** against the nose case.

Head sets should be serviced weekly. Any damaged or worn out parts should be replaced. Check for mandrel wear and replace when necessary. Sherex recommends using high quality socket head cap screws such as Unbrako® and Holo-Krome®.

HEAD SET COMPONENTS

Head sets vary in shape according to the insert thread size. Each head set represents a unique group of components that can be ordered individually and are unique to the size of the fastener. We suggest you keep the components listed below in stock to be used as replacements. (Numbers refer to sketch on previous page).

THREAD SIZE	COMPLETE HEAD SET	1+2 ANVIL	3 MANDREL	4 HEX DRIVER	5 REDUCING SLEEVE
STANDARD RIVET NUTS					
M3	FL5-HS-M3	FL5-HS-00903	M-M3-40	FL5-HS-01003	FL5-HS-09103
M4	FL5-HS-M4	FL5-HS-00904	M-M4-55	FL5-HS-01004	FL5-HS-09104
M5	FL5-HS-M5	FL5-HS-00905	M-M5-65	FL5-HS-01005	FL5-HS-09105
M6	FL5-HS-M6	FL5-HS-00906	M-M6-65	FL5-HS-01006	FL5-HS-09106
M8	FL5-HS-M8	FL5-HS-00908	M-M8-65	FL5-HS-01008	FL5-HS-09108
M10	FL5-HS-M10	FL5-HS-00910	M-M10-65	FL5-HS-01010	XXXX
# 4-40 UNC	FL5-HS-0440	FL5-HS-00854	M-0440-175	FL5-HS-00754	FL5-HS-09154
# 6-32 UNC	FL5-HS-0632	FL5-HS-00856	M-0632-175	FL5-HS-00756	FL5-HS-09156
# 8-32 UNC	FL5-HS-0832	FL5-HS-00858	M-0832-175	FL5-HS-00758	FL5-HS-09158
# 10-24 UNC	FL5-HS-1024	FL5-HS-00850	M-1024-250	FL5-HS-00750	FL5-HS-09150
# 10-32 UNF	FL5-HS-1032	FL5-HS-00850	M-1032-250	FL5-HS-00750	FL5-HS-09150
1/4-20 UNC	FL5-HS-2520	FL5-HS-00848	M-2520-250	FL5-HS-00748	FL5-HS-09148
1/4-28 UNF	FL5-HS-2528	FL5-HS-00848	M-2528-250	FL5-HS-00748	FL5-HS-09148
5/16-18 UNC	FL5-HS-3118	FL5-HS-00840	M-3118-250	FL5-HS-00740	FL5-HS-09140
5/16-24 UNF	FL5-HS-3124	FL5-HS-00840	M-3124-250	FL5-HS-00740	FL5-HS-09140
3/8-16 UNC	FL5-HS-3716	FL5-HS-00842	M-3716-250	FL5-HS-00742	XXXX
3/8-24 UNF	FL5-HS-3724	FL5-HS-00842	M-3724-250	FL5-HS-00742	XXXX
RIVET NUT STUDS					
M5	FL5-HS-M5S	FL5-HS-S0905	FL5-HS-0S005	FL5-HS-01010	XXXX
M6	FL5-HS-M6S	FL5-HS-S0906	FL5-HS-0S006	FL5-HS-01010	XXXX
M8*	FL5-HS-M8S	FL5-HS-S0908	FL5-HS-0S008	FL5-HS-01010	XXXX
# 10-24 UNC	FL5-HS-1024S	FL5-HS-S0850	FL5-HS-S1024	FL5-HS-01010	XXXX
# 10-32 UNF	FL5-HS-1032S	FL5-HS-S0850	FL5-HS-S1032	FL5-HS-01010	XXXX
1/4-20 UNC	FL5-HS-2520S	FL5-HS-S0848	FL5-HS-S2520	FL5-HS-01010	XXXX
1/4-28 UNF	FL5-HS-2528S	FL5-HS-S0848	FL5-HS-S2528	FL5-HS-01010	XXXX
5/16-18 UNC*	FL5-HS-3118S	FL5-HS-S0840	FL5-HS-S3118	FL5-HS-01010	XXXX
5/16-24 UNF*	FL5-HS-3124S	FL5-HS-S0840	FL5-HS-S3124	FL5-HS-01010	XXXX

*Headsets include p/n FL5-HS-12S92 adaptor nut

RIVET NUT STUD HEAD SET ASSEMBLY

Nose Casing

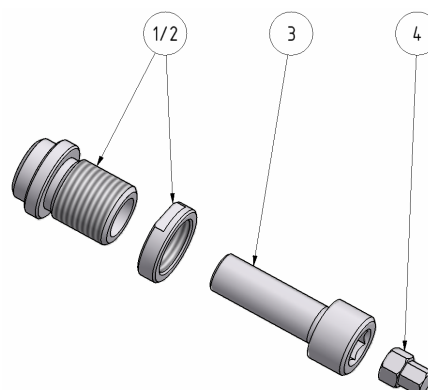
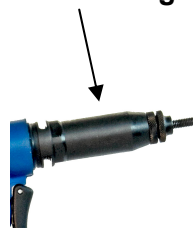

HEAD SET COMPONENTS - RIV-FLOAT®

(Numbers refer to sketch on previous page 6)

THREAD SIZE	COMPLETE HEAD SET	1+2 ANVIL	3 MANDREL	4 HEX DRIVER	5 REDUCING SLEEVE
RIV-FLOAT®					
<small>Riv-float® is covered under U.S. Patent No. 7,713,011</small>					
M3	FL5-HS-2528R	FL5-HS-00848	M-2528-225	FL5-HS-00748	FL5-HS-09148
M4	FL5-HS-2528R	FL5-HS-00848	M-2528-225	FL5-HS-00748	FL5-HS-09148
M5	FL5-HS-M5R	FL5-HS-R0995	M-M5-65	FL5-HS-01005	FL5-HS-09105
M6	FL5-HS-M6R	FL5-HS-R0996	M-M6-65	FL5-HS-01006	FL5-HS-09106
# 4-40 UNC	FL5-HS-2528R	FL5-HS-00848	M-2528-225	FL5-HS-00748	FL5-HS-09148
# 6-32 UNC	FL5-HS-2528R	FL5-HS-00848	M-2528-225	FL5-HS-00748	FL5-HS-09148
# 8-32 UNC	FL5-HS-2528R	FL5-HS-00848	M-2528-225	FL5-HS-00748	FL5-HS-09148
# 10-24 UNC	FL5-HS-1024R	FL5-HS-R0950	M-1024-250	FL5-HS-00750	FL5-HS-09150
# 10-32 UNF	FL5-HS-1032R	FL5-HS-R0950	M-1032-250	FL5-HS-00750	FL5-HS-09150
1/4-20 UNC	FL5-HS-2520R	FL5-HS-R0948	M-2520-250	FL5-HS-00748	FL5-HS-09148
1/4-28 UNF	FL5-HS-2528R1	FL5-HS-R0948	M-2528-250	FL5-HS-00748	FL5-HS-09148
RIV-FLOAT®-SHORT					
<small>Patent Pending</small>					
M4	FL5-HS-M4SR	FL5-HS-SR0994	M-M4-55	FL5-HS-01004	FL5-HS-09104
M5	FL5-HS-M5SR	FL5-HS-SR0995	M-M5-65	FL5-HS-01005	FL5-HS-09105
# 8-32 UNC	FL5-HS-0832SR	FL5-HS-SR0858	M-0832-150	FL5-HS-00758	FL5-HS-09158
# 10-24 UNC	FL5-HS-1024SR	FL5-HS-SR0950	M-1024-225	FL5-HS-00750	FL5-HS-09150
# 10-32 UNF	FL5-HS-1032SR	FL5-HS-SR0950	M-1032-225	FL5-HS-00750	FL5-HS-09150

STROKE ADJUSTMENT PROCEDURE

Determine the proper stroke distance of the tool based on the size and style of rivet nut insert you are using for your application material thickness. Contact Sherex should you require assistance determining the appropriate stroke. **Warning**** A stroke setting that is too large for the application may cause an over installed installation condition which may damage the mandrel, the base material, and/or the rivet nut insert.

Install the proper head set for the rivet nut thread size that you will be using. Attach an air supply to the Air Inlet (1) per the recommendations in this manual.

To adjust the stroke distance of the tool, use the key provided with the tool and place it in the stroke adjustment ring (3) located in the cut out of the back cover. The ring, when threaded fully in, will pull to 1 mm (0.040") of stroke. Turning the key counter-clockwise from one side of the window to the other will increase the stroke approximately .12 mm (.005). Continue to adjust the ring out until you have approximated the stroke distance required. Test by installing a rivet nut and measuring the collapsed distance of the part. Adjust the ring as required to achieve the desired installation distance. **Note**** Threading the adjustment ring beyond the 6 mm stroke may cause the auto-reverse to not function. If this occurs, turn the adjustment ring in the opposite direction reducing the stroke distance to 6 mm.

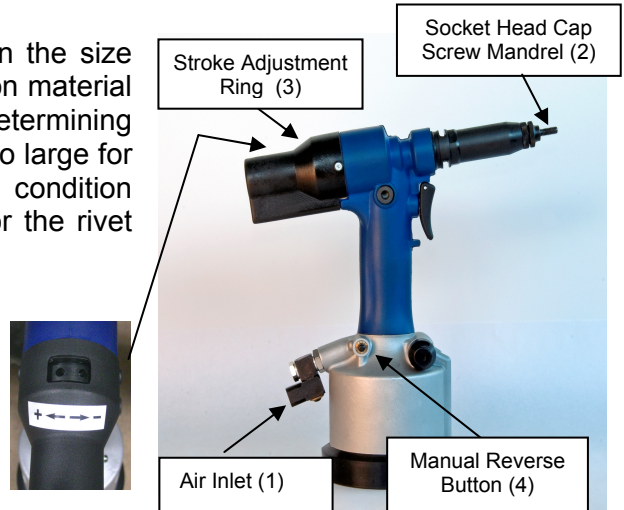

Thread an insert/rivet nut on to the mandrel (2) 1 or 2 turns. Apply pressure to the insert and the auto-spin on feature will engage thereby spinning the rivet nut up the mandrel (2) until it comes in contact with the anvil.

If during the set up process the tool does not automatically reverse out of the rivet nut press the manual reverse button (4).

Operation

Operating procedure

- Head Set assembled, tool connected to air supply, stroke adjustment complete.
- Screw the rivet nut onto the mandrel (2) a couple turns, then a light pressure on it will start the spinning of the mandrel (push to spin) and automatically stop when the rivet nut comes in contact with the anvil.
- Insert fastener into the application.
- Depress the trigger fully. This will place the insert and automatically reverse the tool out of the installed rivet nut. (Depress the trigger and hold until auto-reverse engages). If auto-reverse does not engage and insert has not collapsed, apply a manual pushing force to engage the auto spin-on, and then depress the trigger. (Ensure the air pressure is within the specified range).
- If, at any time, manual-reverse (4) needs to be engaged, depress the button at the base of the handle, to the right of the air inlet.

IMPORTANT

Do not push the mandrel without a rivet nut as this will cause the mandrel to spin automatically. Ensure pressure settings are correct.

Servicing should be performed on a regular basis and a complete inspection will be needed once a year or every 500,000 cycles, whichever comes first.

IMPORTANT

The employer is the sole responsible party for ensuring the training of staff on proper tool use and maintenance. The operator should not perform any servicing or repairs, unless properly trained.

DAILY SERVICING

- Every day, before use, pour a few drops of light lubricating oil on tool air inlet, if the air supply is not equipped with lubricator.
- Check for air leaks. If damaged, hoses and coupling should be replaced.
- Make sure you are using the proper head set.
- Make sure the pull stroke is correct for the selected rivet nut.
- Check the mandrel for wear or damage and replace if needed.

WEEKLY SERVICING

- Check for oil and air leaks.

MAINTENANCE

Every 500,000 cycles the tool should be completely checked and parts that are worn or damaged should be replaced. O rings should be replaced and lubricated with Molykote® 55M grease before assembly.

Only a trained technician should service the Flex 5S tool. Should the Flex 5S tool require repair, the tool can be sent to the Sherex authorized repair center:

Alcorn Industrial, Inc
5412 Rock Hampton Court
Indianapolis, IN 46268
sales@alcornindustrial.com
1-800-317-4775

PRIMING PROCEDURE

- Place the tool on its side with the oil plug facing up.
- With a 5mm Allen key, unscrew the oil plug
- Fill tool with DEA Astron HLP 32 hydraulic fluid, or equivalent
- Gently rock tool back and forth to express any trapped air
- Return oil plug and tighten
- Connect air supply and cycle the tool multiple times
- Disconnect air supply and unscrew oil plug a few turns
- Re-tighten oil plug
- If, at any time, oil is leaking from the reservoir, replace the o-ring located at the top of the threaded section.

SYMPTOM	POSSIBLE CAUSE	SOLUTION
Pneumatic motor runs slowly	<ul style="list-style-type: none"> ⇒ Motor air leaks ⇒ Low air pressure ⇒ Air vanes jammed 	<ul style="list-style-type: none"> ⇒ Check for worn out seals. Replace ⇒ Increase it ⇒ Lubricate tool through air inlet
Insert does not deform properly	<ul style="list-style-type: none"> ⇒ Pull stroke not set properly ⇒ Air pressure outside limits ⇒ Low oil level ⇒ Insert out of the grip 	<ul style="list-style-type: none"> ⇒ Adjust ⇒ Adjust ⇒ Add oil and prime ⇒ Check the insert grip range
Mandrel does not spin	<ul style="list-style-type: none"> ⇒ Mandrel worn/damaged ⇒ Hex Driver worn/damaged ⇒ Loose locking ring 	<ul style="list-style-type: none"> ⇒ Replace Mandrel ⇒ Replace Hex Driver ⇒ Tighten Locking Ring
Insert does not spin on the mandrel	<ul style="list-style-type: none"> ⇒ Incorrect insert thread ⇒ Incorrect mandrel ⇒ Mandrel out or damaged 	<ul style="list-style-type: none"> ⇒ Replace with proper insert ⇒ Replace with proper mandrel ⇒ Replace
Tool is locked in installed insert	<ul style="list-style-type: none"> ⇒ Excessive pull stroke ⇒ Defective insert ⇒ Defective or worn out or damaged mandrel 	<ul style="list-style-type: none"> ⇒ Depress manual spin off ⇒ If this does not work, disconnect air, insert a pin through nose casing slots and unscrew. ⇒ Contact Sherex ⇒ Replace Mandrel
Mandrel breaks prematurely	<ul style="list-style-type: none"> ⇒ Excessive pull stroke ⇒ Side load on mandrel 	<ul style="list-style-type: none"> ⇒ Reduce pull stroke ⇒ Keep the tool square to the application when placing insert
Tool does not spin on insert	<ul style="list-style-type: none"> ⇒ No air supply ⇒ Insufficient distance between locknut and spindle ⇒ Air motor jammed 	<ul style="list-style-type: none"> ⇒ Connect ⇒ Set distance between 1.5 and 2 mm ⇒ Lubricate through air inlet or if required contact Sherex authorized repair center
Auto reverse stops working but the manual reverse does work	<ul style="list-style-type: none"> ⇒ Oil level 	<ul style="list-style-type: none"> ⇒ Check oil level and add more oil to the tool



FLEX-5 Process Monitoring



Features & Benefits

10 inch color touch panel

Connect up to 4 hand tools to each panel

Measure installation force and stroke distance

For blind rivet nuts form M3 to M10 & #4-40 to 3/8-16

Archive installation data through Ethernet/USB port

Prestroke feature accounts for any gaps between rivet nut & anvil, reducing potential faults

Three levels of password control

Customer satisfaction through high reliability and product quality

Cost savings by avoiding complaints, rework and recalls

Additional Options: Bar code printer, x-y balancer, in-line configuration & counter

Displacement and force values are recorded during the installation cycle resulting in a plotted "installation curve." Depending on the processed element and component, the curve develops a specific shape. This specific shape must pass through a user-defined control window, or the system displays an error which can be viewed on the large 10" color touch panel. Therefore, no additional laptop is necessary for programming or display. The system can be integrated with a separate PLC in order to increase assembly system functionality.

Process Monitoring Example

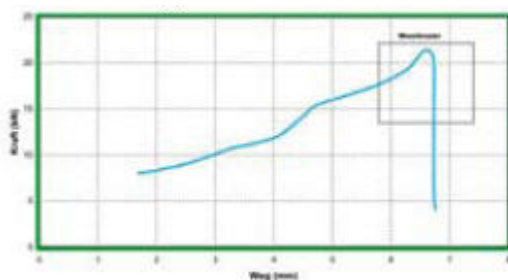

Result "OK", installation
(All control parameters achieved)

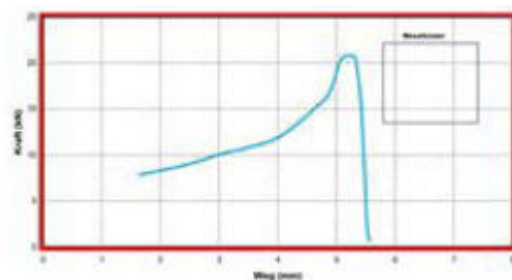

Result "NOT OK", installation
(Full pull distance not achieved)

Sherex offers installation tools to meet any & all requirements no matter the size of the application or the size of the rivet nut

FLEX-18



FEATURES AND BENEFITS

The most powerful tool on the market able to utilize Pull to Pressure and Pull to Stroke installation methods.

- Installs Rivet Nuts from M8 to M16 and 5/16-18 to 3/4-10
- Push to start nose piece to spin on fastener
- Single stage trigger
- Automatic reverse with manual reverse bypass
- Quick change mandrel design
- Socket head cap screw mandrel for sizes up to M12 and 1/2-20
- Can be suspended from a balancer
- **18,000 lbs. (80 kN) of pulling force**
- **15 mm (.591 in) of available stroke**
- Upgradeable to process monitoring
- 2-3 second cycle time
- Light weight handle (8.0 lbs.)
- All aluminum handle design for improved durability

SSG Pneumatic Series



Known as "Spin-Spin Tools," this line of tooling is designed to set the rivet nut to a pre-set torque allowing thin wall rivet nuts from 6-32 to 1/2-20 (M3-M12) to be installed in various material thicknesses with no adjustment to the tool. The SSG 800 Series is the Pistol Grip version of the tool. Our SSG 900 Series is the inline version of the tool which is ideal for vertical installations & our Right Angle Inline version of the tool, the SSG-910 Series is meant for applications that are difficult to access.

Hand Tools



M4 Hand Tool
1/4-20 - 1/2-20 (M6 - M12)



LHF 202 Hand Tool
6-32 - 1/4-20 (M3 - M6)



RNHT Hand Tool
6-32 - 3/8-24 (M3 - M10)



M5 Hand Tool
6-32 - 3/8-24 (M3 - M10)

The FLEX line of tooling is just one of many Product lines that Sherex offers to help meet your application requirements

BLIND RIVET NUTS



Blind rivet nuts are suitable for providing load-bearing threads in thin materials & blind applications. Sherex Fastening Solutions offers the most comprehensive line of blind rivet nuts from thin wall parts to heavy duty. Rivet Nuts are available in both an Inch Body Style & Metric Body Style. Special designs are available to meet customer specific needs.

RIV-FLOAT®

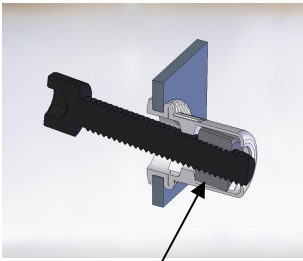

Internally Floating Threads

RIV-FLOAT® is the next generation of fastening technology. Internally floating threads allow for component attachment in off-center applications. RIV-FLOAT® was designed for post finish installation in applications where cage nuts, clinch nuts, floating nut plates or weld nuts are typically used. By aligning to the drive angle of the screw, RIV-FLOAT® accounts for tolerance stack up, saving rework of components and downtime associated with stripped or cross threaded fasteners. RIV-FLOAT®-SHORT is available for applications requiring backside clearance similar to that of various riveted nut plates and cage nuts.

BRASS INSERTS



Brass inserts from Sherex Fastening Solutions are designed to provide a threaded hole in plastics that are not strong enough to support a thread. Brass inserts are available in many options such as ultrasonic, press-in, flanged and molded-in. These inserts have a self aligning lead for accurate installation and can be easily mounted. Suitable industry applications include: automotive, communication and computer equipment, or almost anywhere strong, durable threads are required in plastics.

CLINCH NUTS



Sherex offers three different kinds of clinch nuts to meet the specific requirements of the customer's application. Sherex clinch nuts can be used in various high strength steels such as dual phase alloy, HSLA, and TRIPS to meet class 10 nut strength requirements. Sherex clinch nuts can be used in any material that offers access from both sides of the base material.

FASTENER AUTOMATION



Sherex combines world class fastener manufacturing and design capability with industry leading automation equipment to offer the best solution for your application. This "One Source" service ensures that you are receiving the best support before and after the start of production. Whether you are using 10,000 pieces or 10 million pieces, Sherex offers different levels of automation and fastener capability to meet both your budget and performance requirements.



 **SHEREX FASTENING SOLUTIONS, LLC** 

400 Riverwalk Pkwy., Suite 600

Tonawanda, NY 14150

Phone: 866-474-3739

Fax: 716-875-0358

Email: info@sherex.com

www.sherex.com

 **SHEREX TAIWAN** 

No. 201, Sandong Road, Chungli City

Tao-Tuan Hsien, Taiwan, R.O.C.

Phone: 011-886 3 4988689

Fax: 011-886 3 4989395

Email: sales@sherex.com.tw

www.sherex.com.tw

 **SHEREX MEXICO S. de R. L. de C.V.** 

Riego 6

Col. Los Arquitos

Queretaro, Queretaro

C.P. 76090

Mexico

Phone: 52 (442) 196-8075

Email: ventasmexico@sherex.com

www.sherex.com