

REVISIONS			
REV.	DESCRIPTION	DATE	ECN
A	INITIAL RELEASE	2/4/2014	1655

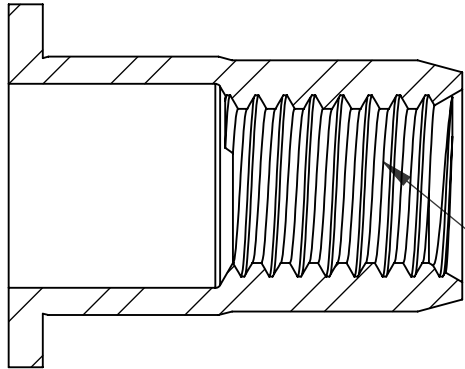
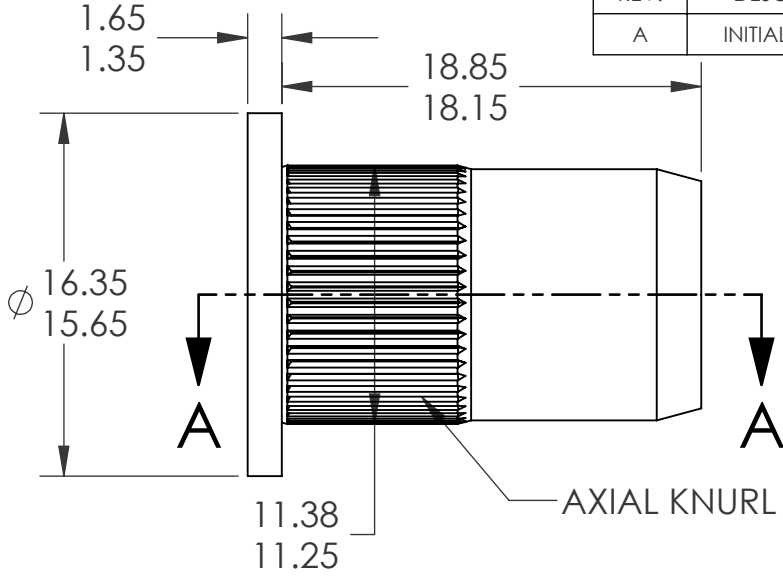
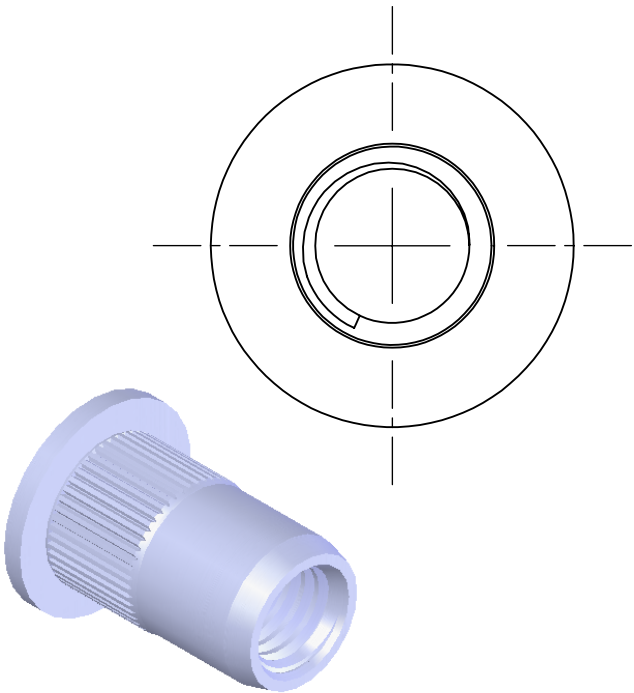

M8X1.25 6H
PER ASME B1.13M
MINOR DIA.: 6.65 - 6.91

SECTION A-A

- NOTE:**
- GRIP RANGE: 3.0 - 5.5
 - HOLE SIZE: 11.5 +0.1/-0.0 AFTER ALL APPLIED FINISHES.
 - INSTALLED LENGTH: N/A
 - INSTALLED THREAD DEPTH:
 - LUBRICATION: NONE
 - INSTALLATION TOOL: FLEX 5P/5S SPIN PULL

PROPRIETARY AND CONFIDENTIAL
THIS DRAWING, AND THE INFORMATION CONTAINED HEREIN, ARE THE PROPERTY OF SHEREX AND ARE NOT TO BE USED IN ANY MANNER DETRIMENTAL TO THE INTEREST OF THE COMPANY.
SHEREX SOLUTIONS RESERVES THE RIGHT TO REVISE PART/DRAWING WITHOUT NOTICE.

		UNLESS OTHERWISE SPECIFIED:		NAME	DATE
		DIMENSIONS ARE IN MILLIMETERS TOLERANCES: ANGULAR: MACH ± 1 BEND ± 1 ONE PLACE DECIMAL ± 0.10 TWO PLACE DECIMAL ± 0.05	DRAWN	JMC	2/4/2014
		INTERPRET GEOMETRIC TOLERANCING PER: ASME Y14.5M-1994	CHECKED		
		MATERIAL	ENG APPR.	JVK	2/4/2014
		STEEL DIN QST 34-3	MFG APPR.		
		FINISH	Q.A.	JR	2/4/2014
		ZINKTOP CLEAR, ROHS COMPLIANT 96W/480R	COMMENTS:		
NEXT ASSY	USED ON		E-mail: info@sherex.com www.sherex.com Phone: 866-474-3739 Fax: 716-875-0358		
APPLICATION		DO NOT SCALE DRAWING			

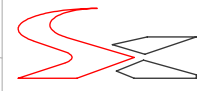

TITLE:
FLAT HEAD OPEN END

SIZE DWG. NO.	REV
A TU-SM8UPO55RZT	A
SCALE: 2:1	WEIGHT: .0071 kg
SHEET 1 OF 1	